

ACCESSORY SPECIFICATIONS

1. PRODUCT NAME

Rigid Vinyl
Roof Flashing
Accessories
Rigid Vinyl also known as PVC
(Unplasticized Chloride)

2. MANUFACTURER

VINYL CORP.™
8000 N.W. 79th Place
Miami, Florida 33166
Phone: 305/477-6464
Fax: 305/477-4108
National Watts:
800/648-4695

3. PRODUCT DESCRIPTION

Roof Flashing accessories are manufactured by Vinyl Corp.™, using lead-free, virgin vinyl compounds, formulated to have durability and toughness.

Roof Flashing Accessories: Roofing VFL, VFLE, VFLE and VFLEC vinyl flashing are manufactured by Vinyl Corp.™

Durability: They are impervious to corrosion when placed in contact with steel or aluminum frames. Vinyl accessories do not contain plasticizers which could migrate to the surface.

Impact Resistance: Due to superior impact resistance, rigid vinyl accessories are resistant to dents and kinks of corners and edges, during construction.

Corrosion Resistance: Vinyl accessories are impervious to rust, corrosion, galvanic corrosion, electrolysis.

Solid Color: Standard color is white
Paint Adhesion Properties: Excellent, no priming is required.

Ignition Resistance: Rigid vinyl is self extinguishing, and will not continue to support combustion once flame source is removed, therefore it will not cause a fire to re-start or spread. It offers better resistance to burning than many other common building materials.

Electrical Conductivity: Rigid vinyl possesses low electrical conductivity.

Thermal Conductivity: Rigid vinyl is warm to the touch and has a very low transmission of heat or cold, and it is considered an excellent insulator.

Expansion and Contraction: Vinyl Corp.™ Roof Flashing accessories, fastening of accessories to substrate makes the accessories part of the building unit and therefore will move with it as the temperature changes. Consequently the coefficient of expansion of rigid vinyl has little or no bearing on the installation.

Basic Uses: Vinyl roof flashing is used at the end of a roof's edge, holding the roof membrane in place. Flexible enough to accommodate variable pitches, radius, roof lines and corners.

4. TECHNICAL DATA

Applicable Standards:

ASTM C1047
ASTM D3678 Class 2
ASTM-D4216

Limitations: Not recommended for use with hot tar roof installations.

5 INSTALLATION

Applicable Standards:

Installation shall be in accordance with ASTM standards and prevalent industry standards and good practices. Vinyl accessories shall be mechanically fastened to substrate in straight lines or smooth curves.

6. AVAILABILITY AND COSTS

Vinyl Corp.™ accessories are generally priced lower than equivalent products manufactured in galvanized steel and substantially lower than zinc, copper or aluminum. Vinyl Corp.™ accessories are in stock and will usually be shipped within 24 hours after receipt of order. Accessories are marketed nationwide thru distributors and building supply dealers.

7. PACKAGING

275 lb. test, double wall, corrugated boxes.

8. WARRANTY INFORMATION

Available upon request.

Note: All size references are nominal dimensions and subject to normal manufacturing tolerances. All product lengths are 10' unless otherwise noted.

MATERIAL DATA

MINIMUM PROPERTIES	ASTM	@0°F	@32°F	@72°F
Tensile Strength, psi	D-638			6,500
Tensile Modulus, psi	D-638			335,000
Flexural Strength, psi	D-790			10,900
Flexural Modulus, psi	D-790			382,000
Izod Impact(ft.-lbs./in.)	D-256			2
MISCELLANEOUS MINIMUM PROPERTIES			ASTM	@72°F
Heat Distortion Temperature (°F @ 264 psi)			D-648	167
Coefficient of Linear Thermal Expansion (in./in. °F x 10 ⁻⁵)			D-696	3.60
Durometer "D" Hardness				83
Specific Gravity				1.47

PRODUCT NUMBER	DIMENSION A	DIMENSION B	LENGTH	PIECES PER BOX
VFL2x2	2"	2"	10'	25
VFL3x1.75	3"	1-3/4"	10'	25
VFL3x3*	3"	2-7/8"	10'	25
VFL4x2*	4"	2"	10'	25
VFL4x3*	4"	2-7/8"	10'	25

VFL Series Roof Edge Flashing – Protects roofing systems from water damage along entire eave. Flexible enough to accommodate variable pitches, radius roof lines, and other contoured applications.

NOTE: Other sizes and roof pitches available upon request.

* FM Approval pending for noted sizes.

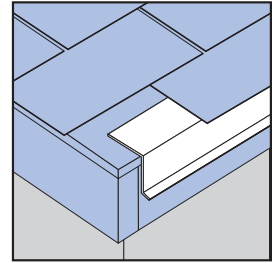
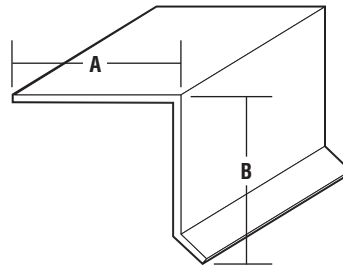

PRODUCT NUMBER	DIMENSION A	DIMENSION B	LENGTH	PIECES PER BOX
VFLC3x3	3"	3"	10'	25
VFLC3.5x3.5	3-1/2"	3-1/2"	10'	25
VFLC4x3*	4"	3"	10'	25
VFLC4x4	4"	4"	10'	25

VFLC Series Roof Edge Flashing – Protects roofing systems from water damage along entire eave. Flexible enough to accommodate variable pitches, radius roof lines, and other contoured applications.

NOTE: Other sizes and roof pitches available upon request.

* FM Approval pending for noted sizes.

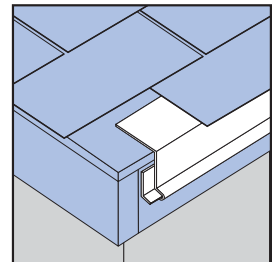
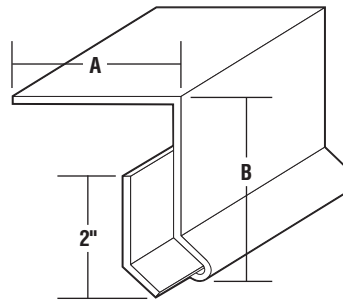

PRODUCT NUMBER	DIMENSION A	DIMENSION B	LENGTH	PIECES PER BOX
VFLE2x2.5	2"	2-1/2"	10'	25
VFLE2x2	2"	2"	10'	25
VFLE3x2	3"	2"	10'	25
VFLE3x3*	3"	2-7/8"	10'	25

VFLE Series Roof Eave Flashing – Protects roofing systems from water damage along entire eave. Flexible enough to accommodate variable pitches, radius roof lines, and other contoured applications.

NOTE: Other sizes and roof pitches available upon request.

* FM Approval pending for noted sizes.

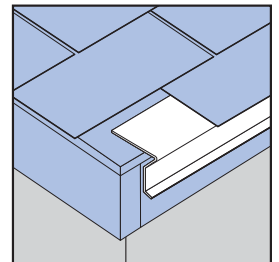
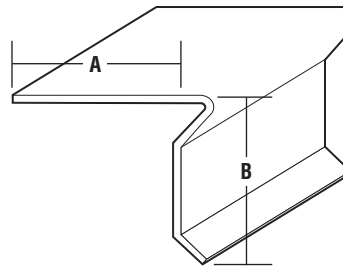

PRODUCT NUMBER	DIMENSION A	DIMENSION B	LENGTH	PIECES PER BOX
VFLEC2x3*	2"	3"	10'	25
VFLEC2x3.5	2"	3-1/2"	10'	25
VFLEC3x3*	3"	3"	10'	25
VFLEC3x4*	3"	4"	10'	25

VFLEC Series Roof Eave Flashing – Protects roofing systems from water damage along entire eave. Flexible enough to accommodate variable pitches, radius roof lines, and other contoured applications.

NOTE: Other sizes and roof pitches available upon request.

* FM Approval pending for noted sizes.

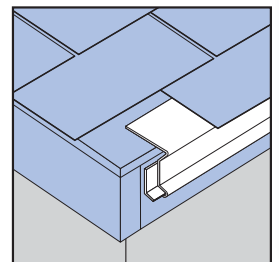
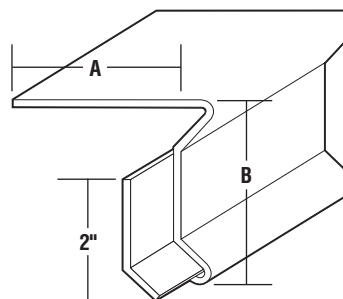

PRODUCT NUMBER	DIMENSIONS	PIECES PER BOX
GF-500	6-1/2" overall width	15
GF-600	7-1/2" overall width	15

GF Series Gutter Filter – Produced in 6-1/2" and 7-1/2" overall width, and helps to protect gutters from debris so they can drain properly. Color: white, sold in 3' or 10' lengths.

Gutter Filter

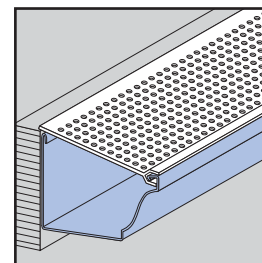
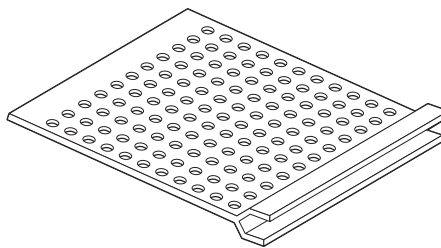

NOTE: In high wind areas, use two sheet metal screws per piece, secure to the front lip of the gutter.





Vinyl Corp. Trademarks

Vinyl Corp.[™], Archmaker[™], Archmaker Series[™], Bandmaker[™],
Bandmaker Series[™] and Keylock[™]

Vinyl Corp. Patents

U.S. Patent Nos. 5,816,002; 5,946,870; 5,970,671; 6,070,374;
6,119,429; 6,134,847; and 6,298,609



Vinyl Corp.[™] • 8000 NW 79th Place • Miami, FL 33166
800.648.4695 • 305.477.6464 • Fax: 305.477.4108

Stucco & Plaster

EIFS & DEFS

Drywall & Veneer

Acoustical Ceiling

Roof Flashing